



PRODUCT CATALOG



+1 (514) 567-5404



info@camautopro.com



100 Boul Prévost #107,
Boisbriand, QC, Canada



www.camautopro.com

FOLLOW US!
@camautopro



ABOUT CAMAUTO

Just because Quality is our main concern, CAMAUTO provides professional PDR technicians, GPR technicians, and Auto Collision Shops, with time and money effective solutions.

Our innovative products and tools are designed and produced to help you execute all sort of dent repair with a minimal time frame.

CAMAUTO SOLUTIONS include Tabs, Pullers, Lifters, Glue, Glue Guns, Hammers, Welders, and Staplers.

But that is just the beginning. Every CAMAUTO Product is backed with world-class research, testing, service, and training support.

With our continuous innovative products, CAMAUTO's aim is to keep providing the glue pulling industry with the best and most reliable tools.



A HUGE DIFFERENCE IN THE INDUSTRY THROUGHOUT THE YEARS

Since Cam Auto Was Founded, It Was Dedicated To
Maintain Customers Satisfaction Through The Services
That We Provide. Our Products Are Tested Before
Offering Them To Our Customers To Insure That Our
Customers Will Benefit Both Technically And Financially.



MEMBER™

MOBILE CARTS

TABS

GLUE GUNS & GLUE

PULLERS & LIFTERS

HAMMERS

KITS

WELDERS

KNOWCKDOWNS

LIGHTS

THE BEST OPTION FOR BODY SHOP TECHNICIANS LOOKING TO IMPROVE TIME AND MONEY EFFICIENCY WITH A COMPLETE **GLUE PULLING SYSTEM!**



- **MOBILE TOOL CART:** that helps you carry all your PDR and GPR tools. Equipped with a drawer, and with a steel tab organizer top for better tools and tabs organization, and with two foldable trays, that can be used as a side table, and that can be bent for a better storage space. Comes with 3 electric plug inputs and 2 USB charging inputs.
- **BODY SHOP LIGHT**
- **ELITE PRO LIGHT PULLER**
- **ELITE DOUBLE FEET**
- **SMART MINI LIFTER**
- **LONG LEVER PULLER 3FT**
- **I-BAR MINI KIT** (4 I-bars in 2 different sizes, and 3 aluminum hooks)
- **CAMAUTO GLUE STICKS** - 20 pcs
- **CAMAUTO BARE METAL GLUE**
- **300W UL APPROVED GLUE GUNS** with temperature adjustment control - 2 pcs

- **COLD GLUE TABS**
- **SERGIO COLD GLUE**
- **BODY SHOP TABS**
- **4 LONG TABS** in 2 different sizes
- **15 FLEX TABS** in 3 different sizes
- **BLACK PLASTIC HOOKS** - 20 pcs
- **B7 MINI LIFTER**
- **BIG KNOCKDOWN**
- **KNOCKDOWN KIT** - 4 pcs
- **3D TABS kit** - 8 pcs
- **3D CURVE TABS** - 8 pcs
- **FLAT TABS kit** - 18 pcs
- **UNIVERSAL ADJUSTABLE TABS kit**- 24 pcs
- **UNIVERSAL CREASE TABS**
- **BAR TABS** - 2 pcs
- **LIGHT COLLISION CARBON HAMMER**
- **LONG PDR SLIDE HAMMER**
- **SLIDE HAMMER 5LBS**
- **VERTICAL PULLING RODS** - 3 pcs

SKU CRT9922

5,750.00 USD

A HEAVY DUTY, MOBILE CART THAT HELPS YOU CARRY ALL YOUR PDR AND GPR TOOLS.



SKU CRT9920

3,800.00 USD

- ELITE PRO LIGHT PULLER
- ELITE DOUBLE FEET
- LONG LEVER PULLER 3FT
- I-BAR MINI KIT (4 I-bars in 2 different sizes, and 3 aluminum hooks)
- CAMAUTO GLUE STICKS - 20 pcs
- 300W UL APPROVED GLUE GUN with temperature adjustment control
- 4 LONG TABS in 2 different sizes
- 15 FLEX TABS in 3 different sizes
- BLACK PLASTIC HOOKS - 20 pcs

- MINI LIFTER
- BIG KNOCKDOWN
- KNOCKDOWN KIT - 4 pcs
- 3D TABS kit - 8 pcs
- 3D CURVE TABS - 8 pcs
- FLAT TABS kit - 18 pcs
- UNIVERSAL ADJUSTABLE TABS kit - 24 pcs
- UNIVERSAL CREASE TABS
- BAR TABS - 2 pcs
- SLIDE HAMMER 5LBS
- PULLING RODS - 3 pcs

CAMAUTO BODYSHOP TABS KIT 2PCS

TABS

- Specially designed for large repairs on the most stubborn panels
- Made from highly strong and durable plastic
- Multi direction pulls



SKU TAB4030

120.00 USD

CAMAUTO COLD GLUE TABS 6PCS

TABS

- Works perfectly with any cold glue
- Comes in 6 different sizes and shapes
- Aluminum smooth surface providing the best adhesion
- Universal adaptor allows you to work with any slide hammer



SKU TAB7001

75.00 USD

MULTI DIRECTION EDGE TABS

TABS

- Offer an easy solution for pulling curved edges
- Pulls in any direction
- Heavy-duty aluminum support ensures strong pulls
- Flexible tab molds to any curved edge
- Includes 4 long plastic tabs in 2 sizes



SKU TAB2023

92.00 USD

CAMAUTO HAIL GLUE TABS VARIETY PACK

TABS

- Provide a smooth surface for secure adhesion
- Engineered for maximum pull strength and a lower failure rate
- Designed for optimal cohesion with any high-quality adhesive
- Deliver top performance for hail repair and body shop technicians

09mm - 2 pcs

11mm - 2 pcs

13mm - 2 pcs

15mm - 2 pcs



SKU TAB08VP

30.00 USD

UNIVERSAL CREASE TABS 24 PCS

TABS

- Heavy-duty Universal Crease Tabs for quick, easy crease removal
- 24 pieces kit with 8 sizes and shapes (flat and round surface) to fit any crease
- Compatible with all PDR and CAMAUTO pullers, lifters, and standard pullers
- Durable, reusable tabs
- Made from heavy-duty material with stainless steel hooks
- Height adjustable for deep dent access
- Can be reused after cleaning following each use

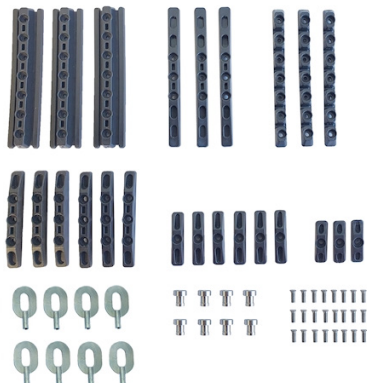

24 pcs

SKU TAB2121

120.00 USD

CAMAUTO FLAT TABS (18PCS)

TABS

- Heavy-duty Flat Tabs for deep hail dents and flat surface damage
- 18-piece kit with 3 pieces in 6 sizes to fit all dent types
- Height adjustable for optimal deep dent access
- Universal threaded stainless steel for compatibility with PDR, CAMAUTO, and standard pullers, lifters, rope ratchets, and chains
- Durable and reusable
- Made from heavy-duty material
- Can be reused after cleaning following each use

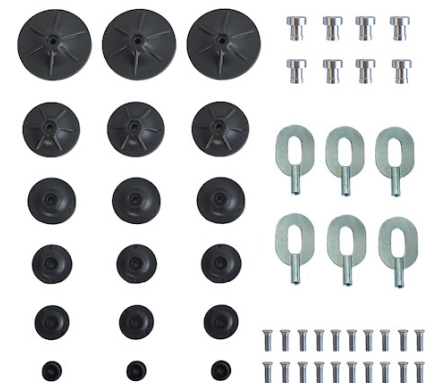

18 pcs

SKU TAB8999

85.00 USD

CAMAUTO UNIVERSAL ADJUSTABLE TABS (24PCS)**TABS**

- Designed for deep dents and various dent shapes, especially sharp dents
- 24-piece kit with V, L, round, and rectangular shapes for versatile dent pulling solutions
- Height adjustable for optimal deep dent access
- Universal threaded solid material for compatibility with multiple adapters
- Compatible with all PDR and CAMAUTO pullers, lifters, and standard pullers, as well as rope ratchets and chains
- Durable, reusable tabs made from heavy-duty material
- Can be reused after cleaning following each use

**24 pcs****SKU TAB2268****90.00 USD****CAMAUTO 3D TABS (8PCS)****TABS**

- Heavy-duty Super Strong 3D Tabs, designed for deep dents and all types of dent shapes
- 8-piece kit with 4 sizes to fit every possible dent shape
- Unique design featuring flexible, bendable side wings for maximum reach and grip
- Height adjustable for optimal deep dent access
- Durable, reusable 3D tabs made from heavy-duty material
- Can be reused after cleaning following each use

**8 pcs****SKU TAB2281****160.00 USD****CAMAUTO 3D CURVE TABS (8PCS)****TABS**

- 3D Curved Tabs for all sizes of curved dents and body lines, such as fenders and quarter panels
- 8-piece kit with curved shapes in 4 sizes for the best solution for any dent shape and location
- Durable, reusable tabs made from BASF's highly flexible heavy-duty material, providing incredible pull strength.
- Can be reused after cleaning following each use

**8 pcs****SKU TAB9009****195.00 USD****CAMAUTO FLEX TABS 0.8 " X 2.5 " (5PCS)****TABS**

- Heavy-duty Flex Tabs designed for small to large deep dents and all types of dent shapes
- Flexible and bendable tabs that fit any dent shape
- Unique, strong design and material
- Durable, reusable tabs made from heavy-duty material
- Can be reused after cleaning following each use

**5 pcs****SKU FTS8250****30.00 USD****CAMAUTO FLEX TABS 1.5 "X 2.5 " (5PCS)****TABS**

- Heavy-duty Flex Tabs designed for small to large deep dents and various dent shapes
- Flexible, bendable tabs that adapt to any dent shape
- Strong and unique design with durable materials
- Durable, reusable tabs made from heavy-duty materials
- Can be reused after cleaning following each use

**5 pcs****SKU FTS1525****40.00 USD****CAMAUTO FLEX TABS 2" X 2.5" (5PCS)****TABS**

- Heavy-duty Flex Tabs designed for a range of deep dents, from small to large, and various dent shapes
- Flexible, bendable tabs that conform to any dent shape
- Strong, unique design with high-quality materials
- Durable, reusable tabs made from heavy-duty materials
- Can be reused after cleaning following each use

**5 pcs****SKU FTS2253****50.00 USD**

CAMAUTO LONG TAB 1.5"X6" (1PC)**TABS**

- Heavy-duty Long Tabs designed for small to large deep dents and all dent shapes
- Bendable tabs that conform to any dent shape
- Strong, unique design with durable materials
- Durable, reusable tabs made from heavy-duty materials
- Can be reused after cleaning following each use

**1 pc****SKU LTS1560****12.00 USD****CAMAUTO LONG TAB 2"X6" (1PC)****TABS**

- Heavy-duty Long Tabs designed for small to large deep dents and all dent shapes
- Bendable tabs that fit any dent shape
- Unique, strong design with durable materials
- Durable, reusable tabs made from heavy-duty material
- Can be reused after cleaning following each use

**1 pc****SKU LTS2060****12.00 USD****CAMAUTO STRONG PLASTIC HOOKS (10PCS)****TABS**

- Can be used on Flex Tabs for small to medium dents and on long tabs for medium to large dents
- Made from heavy-duty material, these hooks allow for strong pulls without the risk of breaking
- Durable, reusable hooks
- Easy to install and remove; simply attach the hooks to the tabs with your hands and move them between tabs as needed
- Can be reused after cleaning following each use

**10 pcs****SKU PHK2021****40.00 USD****CAMAUTO BAR TABS (2PCS)****TABS**

- CAMAUTO BAR TABS 2-piece kit is a versatile multi-task tool
- Can be used as a scraper to remove glued tabs without damaging the paint
- Ideal for trim molding
- Placed between the hammer and the car body panel during knockdown, they act as a shield to protect the paint
- Can be used for both vertical and horizontal strong straight pulls, particularly for gap adjustments
- Durable, reusable tabs made from heavy-duty material
- Can be reused after cleaning following each use

**2 pcs****SKU TAB5005****22.00 USD****I-BAR MINI KIT****TABS**

- The ideal solution for rocker panel body lines, dog legs, and all corners and edges pulls
- 4 pieces kit includes two medium and two large heavy-duty long I-bar plastic tabs with aluminum hooks
- Can be used without the bendable tabs for strong vertical and horizontal straight pulls, especially for gap adjustments
- Can be used with the bendable tabs for maximum glue adhesion between gaps, such as between the quarter panel and rear door
- Durable tabs made from heavy-duty material
- Can be reused after cleaning following each use

**4 pcs****SKU TAB3005****170.00 USD****MINI 3D TABS****TABS**

- Heavy-duty Flex Tabs designed for a range of deep dents, from small to large, and various dent shapes
- Flexible, bendable tabs that conform to any dent shape
- Strong, unique design with high-quality materials
- Durable, reusable tabs made from heavy-duty materials
- Can be reused after cleaning following each use

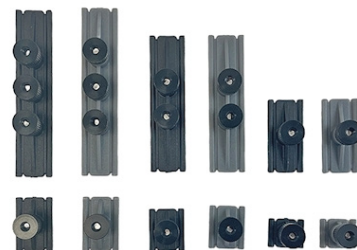
**TAB2283****60.00 USD**

VERTICAL PULLING RODS SET OF 3**TABS**

- 3 strong pulling rods in 3 sizes: 6", 8", and 11", designed to fit all tabs
- Includes a stopper to prevent sliding during vertical pulls

**3 pcs****RDS1166****42.00 USD****M4 STEEL HOOKS 5PCS****TABS**

- 4mm steel hooks. Compatible with Camauto's flat tabs, universal tabs, and 3D curve tabs.

**5 pcs****HKS4044****18.00 USD****M6 STEEL HOOKS 5PCS****TABS**

- 6mm steel hooks. Compatible with Camauto's 3D tabs.

**5 pcs****HKS6066****18.00 USD****GLUE GUN 300W****GLUE GUN**

- The I4 glue gun 300W is a professional-grade industrial high-temperature tool, featuring 300W of heating power for rapid heating in just up to 3 minutes.
- Equipped with a power light indicator.
- Adjustable temperature control lets you set the temperature between 130-220°C (265-445°F) for versatile use.
- Ergonomic long trigger design requires less effort during operation.
- Works with a voltage range of 100V-240V, 50Hz-60Hz.
- Includes a built-in stand for stability.

**GUN2222****50.00 USD****CAMAUTO COLLISION GLUE PACK OF 10****GLUE**

- A high-strength adhesive, tested on all types of dents, shapes, and sizes, and under all weather conditions -from extreme cold to intense heat, and from high humidity to dry environments.
- A slow-curing, flexible glue that makes it easy to work on large and tough dents.
- Longer setting time allows you to work on multiple dents with multiple tabs simultaneously.
- Ideal application time is 1 to 2 minutes for small to medium dents.
- Best applied 3 to 5 minutes for larger dents and collision repairs.
- Exceptional pulling strength. Camauto Pro Glue has passed all tests with PDR and GPR tools, ranking among the strongest. It was even able to lift a V6 car with just one glued tab.

**10 pcs****GUN2215****20.00 USD****CAMAUTO COLLISION GLUE PACK OF 20****GLUE**

- A high-strength adhesive, tested on all types of dents, shapes, and sizes, and under all weather conditions -from extreme cold to intense heat, and from high humidity to dry environments.
- A slow-curing, flexible glue that makes it easy to work on large and tough dents.
- Longer setting time allows you to work on multiple dents with multiple tabs simultaneously.
- Ideal application time is 1 to 2 minutes for small to medium dents.
- Best applied 3 to 5 minutes for larger dents and collision repairs.
- Exceptional pulling strength. Camauto Pro Glue has passed all tests with PDR and GPR tools, ranking among the strongest. It was even able to lift a V6 car with just one glued tab.

**20 pcs****GUN2214****38.00 USD**

CAMAUTO SUPER FAST PDR GLUE PACK OF 10**GLUE**

• Camauto Pro Super Fast PDR Glue is a high-strength, low-temperature adhesive, tested on all shapes and sizes of dents, and under all weather conditions, from extreme cold to intense heat, and from high humidity to dry environments. Fast-curing and flexible, it makes working on small and tough dents easier.

Extremely quick setup time allows you to work faster, with the glue drying in less than 15 seconds. Best applied for a 15-second duration.

Low-temperature formulation, compatible with any low-temperature glue gun, requiring minimal heat.

Excellent pulling strength. Camauto Pro Glue has passed all tests with PDR and GPR tools, ranking among the strongest adhesives available.

**10 pcs****GLU2217****22.00 USD****CAMAUTO BARE METAL GLUE (10 PACK)****GLUE**

PDR & GPR collision glue, specially formulated and tested for bare aluminum and steel, as well as painted and sanded surfaces.

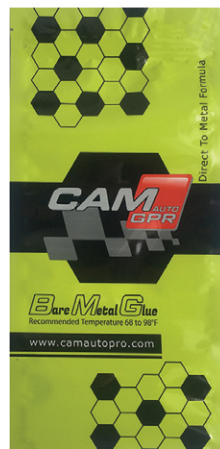
**10 pcs****GLU2218****24.00 USD****CAMAUTO GLUE CASE 450 STICKS****GLUE**

• A high-strength adhesive, tested on all types of dents, shapes, and sizes, and under all weather conditions -from extreme cold to intense heat, and from high humidity to dry environments.

• A slow-curing, flexible glue that makes it easy to work on large and tough dents.

• Longer setting time allows you to work on multiple dents with multiple tabs simultaneously.

• Ideal application time is 1 to 2 minutes for small to medium dents.

• Best applied 3 to 5 minutes for larger dents and collision repairs.

• Exceptional pulling strength. Camauto Pro Glue has passed all tests with PDR and GPR tools, ranking among the strongest. It was even able to lift a V6 car with just one glued tab.

**450 pcs****GLU2216****750.00 USD****BLACK PULL-C (BATTERY OPERATED)****PULLERS & LIFTERS**

• Camauto Black Pull-C is the ideal solution for fixing dents anywhere, even without air.

• Can be used without hooks, straps, or anchors.

• Mobile: Technicians can pull dents without floor pots, simply using the battery-operated suction plate.

• Adjustable height for various pull angles.

• Lightweight construction made from durable T6 aluminum.

• Suction plate height adjustable for easier storage and pad protection.

• Can pull vertically or horizontally, using up to 3 pulling points at the same time.

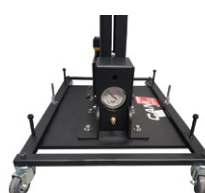
**PUL2291****1,900.00 USD****BLACK PULL-A (AIR OPERATED)****PULLERS & LIFTERS**

• The ultimate solution for fixing dents anywhere.

• Can be used without the need for hooks, straps, or anchors.

• Mobile: Technicians can pull dents without any floor pots, simply using the air-operated suction plate.

• Adjustable height for different pull angles.

• Lightweight, made from durable T6 aluminum.

• Suction plate height is adjustable for easy storage and pad protection.

• Can pull vertically or horizontally, using up to 3 pulling points simultaneously.

**PUL2290****1,600.00 USD****LEG SUPPORT & DOWN PULL****PULLERS & LIFTERS**

• Leg support & down pull is an extension that can be installed on our black pull floor pullers, air and battery operated.

• Allows a much stronger suction for big dent pulls

• Allows you to perform down pulls like rocker panels and any low surfaces.

**PUL2293****250.00 USD**

LIGHTWEIGHT FLOOR PULLER

PULLERS & LIFTERS

- Camauto lightweight floor puller is your best solution for hard to light pulls
- Can be used by PDR technicians and bodyshops as a mobile puller without any floor pots, using the suction plate
- 2 to 4 feet adjustable height for different height pulls



PUL2265
1,550.00 USD

BASIC LATERAL TENSION PUSH/PULL TOOL

PULLERS & LIFTERS

- Tension push/pull tool is the perfect solution to create lateral tension with the best dent reduction results.
- Heavy duty: made from steel and aluminum allowing PDR and GPR technicians to perform strong lateral pulls
- Strong telescopic design
- Easy to use: no tabs needed.
- Comes with 5 additional adaptors in different lengths and a connector
- Swivels in both directions



PUL9013
560.00 USD

LATERAL TENSION PUSH/PULL TOOL

PULLERS & LIFTERS

- Heavy duty: Steel and aluminum construction for strong lateral pulls by PDR and GPR techs.
- Durable telescopic design.
- Extra leg support prevents dents when applying lateral tension.
- Easy to use: Apply glue to the inner feet and use a power drill to push or pull - no tabs needed.
- Includes 5 additional adaptors of different lengths and a connector for various panel surfaces and secondary support.
- Swivels both ways: Move easily to free up space and place a bridge puller for direct dent pulls.
- 4 padded feet for protection.



PUL9010
920.00 USD

DOUBLE FEET FOR LATERAL TENSION PUSH/PULL TOOL

PULLERS & LIFTERS

- 4 padded feet that can swivel to form up to 90° angle so it can fit on any panel surface shape.

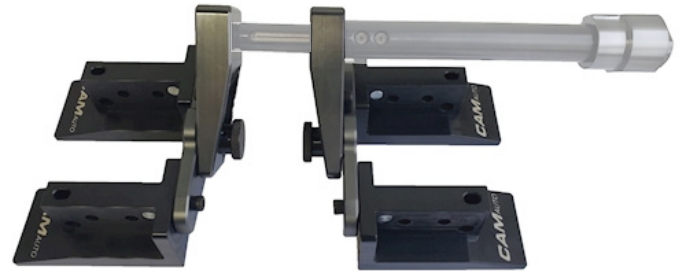

PUL9011
220.00 USD

LATERAL TENSION COLLISION TABS WITH ROPES

PULLERS & LIFTERS

- Leg support & down pull is an extension that can be installed on our black pull floor pullers, air and battery operated.
- Allows a much stronger suction for big dent pulls
- Allows you to perform down pulls like rocker panels and any low surfaces.



PUL9015
140.00 USD

PULLING ROPES SET OF 2

PULLERS & LIFTERS

- Pulls up to 24200 lbs (11t)
- 5/16" (8mm)



PUL9019
60.00 USD

LATERAL TENSION PUSH/PULL TOOL JV ADAPTOR**PULLERS & LIFTERS**

- Lateral tension push/pull tool JV adaptor provides a constant and even pressure.
- The technician can now (load) the panel and gently message the surrounding secondary impact crowns and kinks, as the dent moves in a slow controlled, more precision like manner, giving complete "user" control over "start and stop" movements.

**PUL9012****95.00 USD****PROLIGHT PULLER/LATERAL TENSION TOOL CONNECTORS****PULLERS & LIFTERS**

- Prolight puller/lateral tension tool connectors help you connect your proligh bridge puller to your lateral tension push/pull tool so you can perform a direct pull, while applying lateral tension at the same time.

**PUL1156****75.00 USD****ELITE PRO LIGHT PULLER****PULLERS & LIFTERS**

- Camauto elite pro light puller is our most popular and best seller puller
- Can be used on 80% of all dent shape and size, on steel and aluminum panels
- Lightweight puller with an aluminum bar, aluminum puller, and 2 aluminum and plastic padded feet.
- Loaded with a bearing between the pulling device and the pulling bar
- Can be used with an impact wrench
- Height adjustable feet.
- Swiveling feet & padded feet for a maximum panel and paint protection.
- Universal hook adaptor comes with a hook and a base that can be used on camauto or any other tab

**PUL1155****900.00 USD****ELITE PROLIGHT PULLER DOUBLE FEET****PULLERS & LIFTERS**

- Camauto elite double feet can be installed on the pro light puller, and best used when you don't have a solid panel surface. The double feet will then split the pulling pressure from two to four pressure points, providing greater support, and avoiding any panel damage.
- Lightweight plastic and aluminum feet
- Swiveling feet. Both feet can swivel in all directions, and bend up to 90° to fit on any panel surface.
- Padded feet for a maximum panel and paint protection.

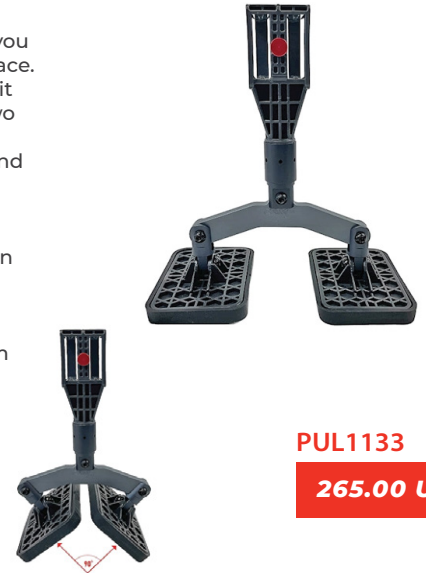
**PUL1133****265.00 USD****LONG LEVER PULLER 4 FEET****PULLERS & LIFTERS**

- Camauto long lever puller is your best solution for very strong pull
- Long leverage bar (4 feet) allows you to make very strong pulls with minimal energy required.
- Best used when the job requires a very strong pull, and you don't have enough space on the panel to use two feet.

**PUL8012****225.00 USD****HEAVY-DUTY ALUMINUM PADDLE WITH STAINLESS STEEL 3 TIP KNOCKDOWN****PULLERS & LIFTERS****PAD2559****90.00 USD**

CAMAUTO STAINLESS STEEL 3 TIP KNOCKDOWN**PULLERS & LIFTERS**

- Camauto stainless steel 3 tip knockdown
- Comes with three tips:
 - Stainless steel round tip
 - Plastic round tip
 - Plastic flat tip

**KKD4544****32.00 USD****CAMAUTO STAINLESS STEEL 3 TIP LONG KNOCKDOWN****PULLERS & LIFTERS**

- Camauto stainless steel 3 tip long knockdown
- Comes with three tips:
 - Stainless steel round tip
 - Plastic round tip
 - Plastic flat tip

**KKD4543****57.00 USD****MULTI HOOK ADAPTOR****PULLERS & LIFTERS**

- Universal: can be attached to any slide hammer or can be used with a ratchet strap

**MHH4444****48.00 USD****UNIVERSAL HOOK ADAPTOR****PULLERS & LIFTERS**

- Universal Hook Adaptor is your ultimate solution to work with any slide hammer, puller, and lifter.
- Universal: Comes with a hook and a base that can be used on any Camauto or any other Tab.

**PUL2277****48.00 USD****SLIDE HAMMER TAB SAVER****PULLERS & LIFTERS**

- No more flying tabs and lost tabs all over the floor
- Heavy duty, light weight adaptor helps your tabs stay attached to your slide hammer.
- Universal: Fits any slide hammer in the market.
- Easy to install in seconds

**PUL2525****95.00 USD****KECO MINI LIFTER TAB SAVER****PULLERS & LIFTERS**

- No more flying tabs and lost tabs all over the floor
- Heavy duty, light weight adaptor helps your tabs stay attached to your keco robo mini dent lifter
- Fits on keco robo mini dent lifter
- Easy to install in seconds
- Adjustable: you can simply adjust it so you can use the mini lifter with or without it

**PUL2526****45.00 USD**

LIP PLIERS**PULLERS & LIFTERS**

- Shaped to give easy access to fender and all other lips

**PUL5484****45.00 USD****SINGLE SIDE PULLER****PULLERS & LIFTERS**

- Camauto single side puller is your best solution for dents located on all sort of edges.
- Single foot makes your job much easier on all edge dents, specially on surfaces where there is not enough space to use double feet.
- Can be used with all universal and camauto tabs.

**PUL6601****135.00 USD****SINGLE SIDE STUD PULLER****PULLERS & LIFTERS**

- Camauto single side stud puller is your best solution for dents located on all sort of edges.
- Single foot makes your job much easier on all edge dents, specially on surfaces where there is not enough space to use double feet.
- Can be used with all panel dent repair machines

**PUL4477****80.00 USD****BIG LIFTER WITH HOOK****PULLERS & LIFTERS**

- Camauto big lifter with hook is your lightweight strong lifter, for strong and sharp, small to medium dents.
- Can be used with all universal and camauto tabs
- Comes with 4 different shape adapters to fit every panel surface

**PUL2246****285.00 USD****ELITE PROLIGHT PULLER CONSTANT TENSION ADAPTOR****PULLERS & LIFTERS**

- Elite prolight puller constant tension adaptor is an add-on to our puller
- Gives you the ability to keep "hands free", constant even pressure, the technician can now (load) the panel and gently message the surrounding secondary impact crowns and kinks, as the dent moves in a slow controlled, more precision like manner, giving complete "user" control over "start and stop" movements.

**PUL7009****78.00 USD****CAMAUTO LIGHT COLLISION CARBON HAMMER****HAMMERS**

- Lightweight 0.6 lbs
- Comes with 4 interchangeable tips (stainless steel and aluminum)

**HMR6605****110.00 USD**

LATERAL TENSION BELT ADAPTORS 2pcs

PULLERS & LIFTERS

- Lateral tension belt adaptors 2pcs



PUL9014

120.00 USD

CAMAUTO SMART MINI LIFTER

PULLERS & LIFTERS

- Camauto smart mini lifter is a must carry heavy duty tool for all PDR and bodyshop technicians.
- 360° rotating base for multiple leverage options.
- 360° rotating handle.
- Padded feet to ensure a better grip and paint protection.
- Sliding feet on a small bridge allowing technicians to work on any dent size or tab size. (Up to 5")
- Smart lock system to help technicians work around dents, while keeping the leverage pressure.
- Height adjustable providing technicians with a 1 inch travel to reach deep dents.
- Interchangeable feet



PUL8050

245.00 USD

SMART MINI LIFTER CREASE TERMINATOR KIT

PULLERS & LIFTERS

- Camauto smart mini lifter crease terminator kit is the one and only kit that allows you to close the lifter feet to 4mm, allowing the technician to stabilize the whole panel, and kill any crease dent in a magical way
- Comes with two padded crease feet
- Comes with 6 4mm plastic tabs in 6 different dimensions



PUL8055

120.00 USD

SMART MINI LIFTER LARGE FEET (2pcs)

PULLERS & LIFTERS

- Smart mini lifter large feet can be installed to help you prevent damaging surrounding metal when working on heavy pulls
- Covers a wider metal surface to focus all the pulling energy into the dent
- Padded feet for better protection



2 pcs

PUL8051

69.00 USD

CAMAUTO B7 MINI LIFTER

PULLERS & LIFTERS

- Camauto B7 mini lifter is a practical tool for pdr technicians due to its light weight and ergonomically handle.
- Lightweight 270 grams
- Solid plastic body
- Padded rubber feet



PUL8052

99.00 USD

PDR HOOK ADAPTER

PULLERS & LIFTERS

- Camauto PDR hook adapter is a heavy duty steel adapter that allows pdr technicians to use their PDR hammers on all Camauto tabs



PUL2266

28.00 USD

CAMAUTO PDR SHORT SLIDE HAMMER**HAMMERS**

- Works on all the tabs in the market
- 3.3 lbs 16" long
- Built in tab saver adaptor
- Stainless steel

**PUL2255****155.00 USD****CAMAUTO PDR LONG SLIDE HAMMER****HAMMERS**

- Works on all the tabs in the market
- 3.5 lbs 19" long
- Built in tab saver adaptor
- Stainless steel

**PUL2256****165.00 USD****SLIDE HAMMER 5 LBS****HAMMERS**

- Camauto slide hammer 5 pounds is a 5lb stainless steel slide hammer that helps you pull out deep dents on all metal surfaces

**PUL2251****145.00 USD****COLD GLUE SLIDE HAMMER ADAPTOR****HAMMERS**

- Camauto cold glue slide hammer adaptor is your best solution to work with cold glue tabs with any regular slide hammer.
- Connects to any slide hammer in seconds
- Easy lock: your tab is perfectly locked inside the adaptor so that it never moves while sticking your tab on the panel, or while performing your pull

**PUL2252****86.00 USD****SLIDE HAMMER WITH HOOK****HAMMERS**

- Slide hammer with hook attachment for fast and reliable pulls.
- 4 lbs weight for heavy dent pulls.

**PUL2253****125.00 USD****CAMAUTO PREMIUM COLD GLUE KIT****KITS**

Camauto premium cold glue kit is the technician's full setup for moving large amount of metal as quickly as possible

- 2 weight adaptors that can be installed in seconds from the outer side, transforming your slide hammer from 1lbs to 3lbs. Whether you are working on small hail dents, or doing some heavy body repair, this slide hammer will never leave your toolbox.
- 3 interchangeable stainless steel rods that allow you to choose the exact travel you need for your adaptor, going from 11" to 18"
- Regular pdr tabs adaptor
- Tab saver adaptor.
- 6 cold glue tabs in different size and shape.
- Sergio's red cold glue

**KIT7711****365.00 USD**

CAMAUTO COLD GLUE KIT

KITS

• Camauto cold glue kit is the technician's best setup for quickly moving large amount of metal

Included in the kit:

- Camauto PDR long slide hammer
- Camauto cold glue tabs - 6 pcs
- Sergio's red cold glue



KIT7700

249.00 USD

PDR TECH KIT

KITS

• PDR TECH KIT is your ultimate kit that carries all sort of tabs to cover any dent shape.

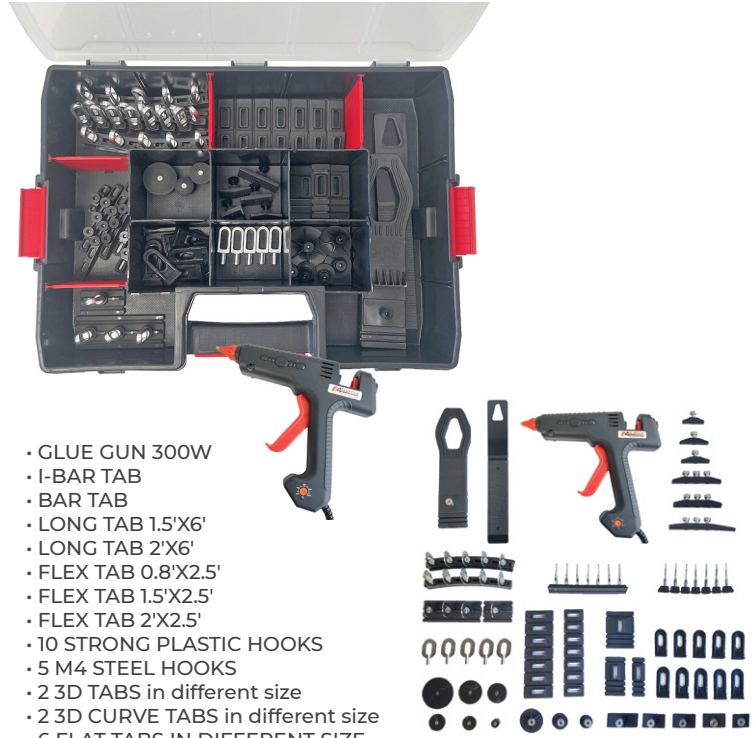

- GLUE GUN 300W
- I-BAR TAB
- BAR TAB
- LONG TAB 1.5'X6'
- LONG TAB 2'X6'
- FLEX TAB 0.8'X2.5'
- FLEX TAB 1.5'X2.5'
- FLEX TAB 2'X2.5'
- 10 STRONG PLASTIC HOOKS
- 5 M4 STEEL HOOKS
- 2 3D TABS in different size
- 2 3D CURVE TABS in different size
- 6 FLAT TABS IN DIFFERENT SIZE
- 8 UNIVERSAL ADJUSTABLE TABS in different size
- 8 CREASE TABS in different size
- PLASTIC CASE

KIT2002

599.00 USD

MONSTER KIT

KITS

• MONSTER KIT carries almost anything you need to repair small, medium, and large dents.

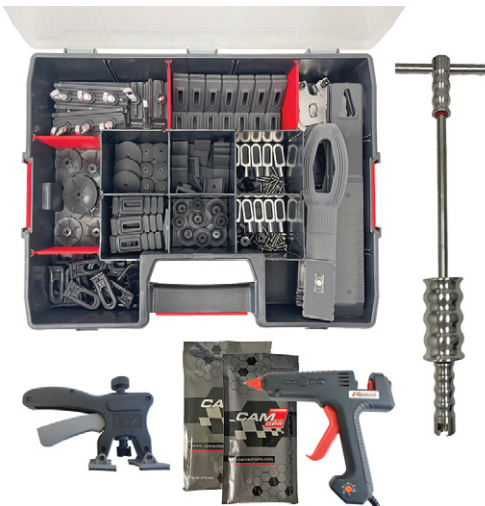

- GLUE GUN 300W UL approved with temperature control
- SLIDE HAMMER 5 LBS
- CAMAUTO GLUE STICKS PACK OF 20
- CAMAUTO GLUE STICKS PACK OF 10
- I-BAR MINI KIT
- BAR TABS 2PCS
- UNIVERSAL ADJUSTABLE TABS (24pcs kit)
- 3D TABS (8pcs kit in 4 different sizes)
- 20 BLACK PLASTIC HOOKS
- 4 LONG TABS in 2 different sizes
- 15 FLEX TABS in 3 different sizes
- FLAT TABS (18pcs kit in 6 different sizes)
- MINI LIFTER
- BIG PLASTIC CASE

KIT2299

1,100.00 USD

PDR WARRIORS KIT

KITS

• PDR warriors kit: when you're equipped with the strongest puller, double feet, all our tabs, adaptors, and tab saver.

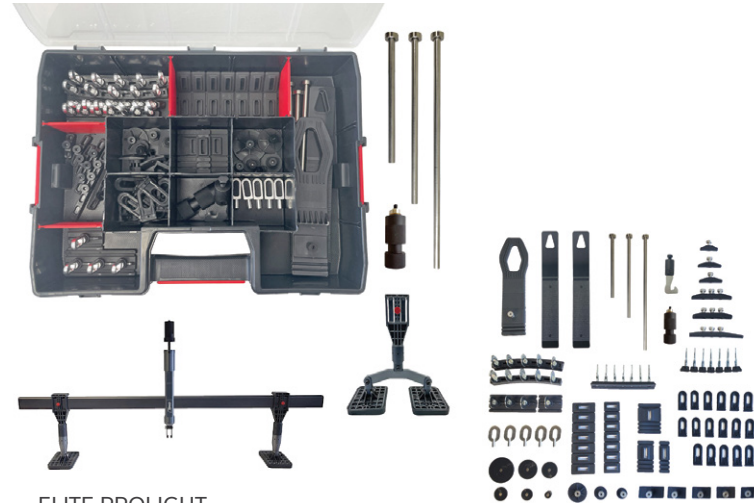

- ELITE PROLIGHT PULLER
- ELITE DOUBLE FEET
- SLIDE HAMMER TAB SAVER
- PDR HOOK ADAPTOR
- VERTICAL PULLING RODS SET OF 3
- I-BAR TAB
- BAR TABS SET OF 2
- LONG TAB 1.5'X6'
- LONG TAB 2'X6'
- FLEX TAB 0.8'X2.5'
- FLEX TAB 1.5'X2.5'
- FLEX TAB 2'X2.5'
- 17 STRONG PLASTIC HOOKS
- 5 M4 STEEL HOOKS
- 2 3D TABS in different size
- 2 3D CURVE TABS in different size
- 6 FLAT TABS in different size
- 8 UNIVERSAL ADJUSTABLE TABS in different size
- 8 CREASE TABS in different size
- PLASTIC CASE

KIT9099

1,668.00 USD

CAR BODY HEATER CBH300**WELDERS**

- CBH300 shrinking machine 1φ 110V with GYS type magnet earth and 5 carbon sticks
- Stepless power adjusting with a very easy adjustable power according to the user needs.
- Powerful main transformer and high duty cycle
- Operates with extremely low power when lowering the power settings, to avoid any panel burn.

**WLD2130****1,099.00 USD****CAR BODY HEATER CBH300A****WELDERS**

- CBH300A shrinking machine 1φ 110V with GYS type magnet earth and 5 carbon sticks and 3 air extensions
- Stepless power adjusting with a very easy adjustable power according to the user needs.
- Powerful main transformer and high duty cycle
- Operates with extremely low power when lowering the power settings, to avoid any panel burn.
- Comes with a built in air cooling system that can be turned on and off. Can be used just for cooling while the rod is not touching the metal, and can be used as well while shrinking the panel.

**WLD2131****1,350.00 USD****CBH200 SHRINKING ROLLER****WELDERS**

- Replace your carbon rods with the new Shrinking Roller for better and faster results on big dent surfaces.

**WLD2145****95.00 USD****CBH EXTENSION SHRINKING STICKS (set of 2)****WELDERS**

- The CBH extension shrinking sticks allows you to have easy access to inner panels, and under braces.
- BENDABLE for easier access and reach.

**2 pcs****WLD2146****85.00 USD****CARBON SHRINKING RODS 5PCS****WELDERS****5 pcs****ROD2026****15.00 USD****HOT STAPLER PLASTIC WELDING MACHINE 110V****WELDERS****WLD2188****195.00 USD**



GRD1133

55.00 USD



WLD2131

45.00 USD

• Dent Pulling straight washers.



100 pcs

WSR2022

45.00 USD

• Dent pulling twisted washers.



100 pcs

WSR2023

45.00 USD

• Dent pulling triangle washer.



10 pcs

WSR3333

10.00 USD



WTP2525

18.00 USD



KKD4545

6.00 USD

• Knockdown 4pcs with 4 different tips for knocking down all crown sizes and shapes.



4 pcs

KKD4546

6.00 USD

- 36 inch led light
- 4 strip - warm cool warm cool
- Rubberized end caps
- Light stand with removable end mount and extendable boom



LGT1155

900.00 USD



www.camautopro.com